

Data Sheet



Article number: 2310313931

Description: E+G Levelling element
LV.F-125-ACV-M24x136

Measures

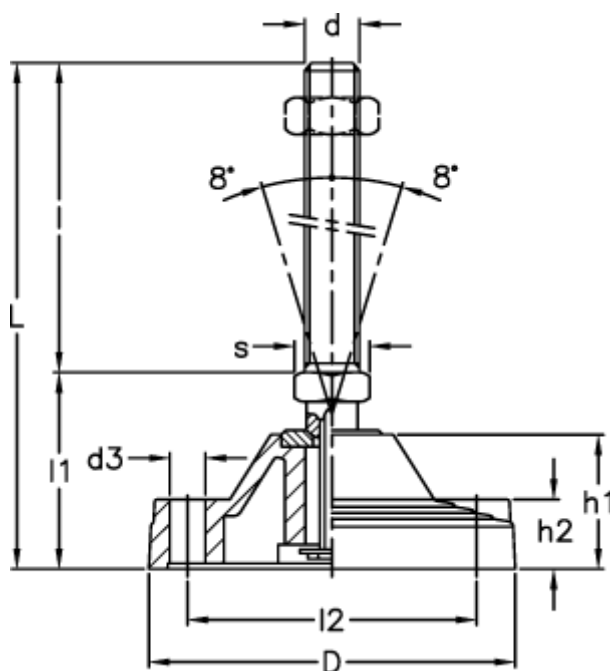

D = 125	l2 = 95
d = M24	Max load (N) = 40000
d3 = 12.5	s = 24
h1 = 45	
h2 = 23	
l = 136	
L = 200	
l1 = 64	